



**AT5100
External
Modulation
Optical
Transmitter**

**Quick Reference
Guide**

Revision 1B

ACT AT5100 External Modulation Optical Transmitter

Quick Reference Guide

ACT Document Number: ACT AT5100 External Modulation Optical Transmitter

Quick Reference Guide Revision 1B

Copyright © 2018 Ascent Communication Technology Limited.

All rights reserved. Reproduction in any manner whatsoever without the express written permission of Ascent Communication Technology is strictly forbidden.

This document is produced to assist professional and properly trained personnel with installation and maintenance issues for the product. The capabilities, system requirements and/or compatibility with third-party products described herein are subject to change without notice.

For more information, contact ACT: support@ascentcomtec.com



Revision History

Revision	Date	Reason for Change
A	01/23/2018	Initial release
B	02/20/2018	Update Sections

Table of Contents

1	Precautions	5
2	Introduction	6
2.1	Overview	6
2.2	Features.....	6
2.3	Specifications	7
2.4	Models and Options.....	8
3	Installation.....	9
3.1	Equipment Inventory	9
3.2	Packaging and Transportation.....	9
3.3	Power and Cooling Requirements.....	9
3.4	Installation and Adjustment.....	10
3.5	Front Panel Operation.....	11
3.6	Rear Panel Operation	12
4	Technical Description	13
4.1	Overview	13
4.2	Physical Description	13
4.3	AGC Operation	13
4.4	SBS Suppression	14
4.5	ITU Frequency Grid	15
5	Software Description – Operation	16
5.1	Web Management	16
5.2	Device Status Submenu	19
5.3	Device Settings Submenu.....	20
5.4	Alarm Status.....	20
5.5	Alarm Properties	21
5.6	Network Settings:.....	21

5.7 Change Password	22
5.8 Reset Settings	22
6 Setup Menu	23

1 Precautions



Warning

Exposure to class 1M laser radiation is possible. Access should be restricted to trained personnel only. Do not view exposed fiber or connector ends when handling optical equipment.

- Ensure adequate cooling and ventilation as specified.
- The installation and operation manual should be read and understood before units are put into use.
- Always replace protective caps on optical connectors when not in use.
- The typical connectors fitted are SC/APC 8°. **Note:** 8° angle polished connectors must be used.

Cleaning

Use only a damp cloth for cleaning the front panel. Use a soft dry cloth to clean the top of the unit.

Do not use spray cleaner of any kind.

Grounding

The XMOD2 Transmitter should have good grounding with grounding resistance $< 4\Omega$.

According to the international standard, 220V plug in adopts tri-wire rule and the middle wire is the grounding wire.

Before connecting circuit, please use proper electric wire (#20AWG and more) to connect the grounding screw and the grounding frame. When use DC input power supply, the equipment chassis must be grounded.

Overloading

Overloading wall outlets and extension cords can result in a risk of fire or electric shock.

Use approved electrical cords.

Damage requiring service

Unplug unit and refer servicing only to Ascent Communication Technology qualified service personnel.

Servicing

Do not attempt to service this unit yourself. Refer all servicing only to Ascent Communication Technology qualified service personnel.

2 Introduction

2.1 Overview

AT5100 1RU Dual Output 1550nm Externally-Modulated (XMOD2) Laser Transmitter offers a flexible, medium and long distance and scalable optical transmission for high quality analog and digital video in CATV networks.

AT5100 XMOD2 1550nm series transmitters are designed with two optical output ports with power from 3 dBm, 6 dBm, 9 dBm, and 10 dBm. These transmitters are equipped with field adjustable Stimulated Brillouin Scattering (SBS) suppression from 13 dBm to 18 dBm. AT5100 XMOD2 series simplifies the application by offering chirp-free operation with confined optical line width and maintain excellent distortion performance CNR, CSO and CTB across the entire network.

AT5100 XMOD2 transmitter provides low dispersion transmission with intuitive front panel LCD display to make operator's life easier. The optical transmitter is packaged in a self-contained 19" sub-rack of 1 RU with dual main power supplies and SNMP management.

Together with ACT 1RU EDFA optical amplifiers, the AT5100 XMOD2 provides an ideal long-distance video and short, medium video overlay solution in high density FTTX networks to bring the CATV services to business and home premises.

2.2 Features

- High performance on CSO, CTB with RF pre-distortion circuit
- Dual optical output power up to 10dBm
- Suitable for long distance 1550 nm DWDM Video transmission applications
- Suitable for short, medium distance FTTH applications
- Low noise DFB continuous wave laser, reduce the dispersion effect
- Optimized models for 60 PAL or 89 PAL channels, 80 NTSC channels or 110 NTSC channels
- Dual redundant hot-swappable AC or DC power supplies
- Field-adjustable Stimulated Brillouin Scattering (SBS) suppression for optimized CSO
- Front-panel LCD for local monitoring of transmitter status
- Local or remote monitoring and configuration
- SNMP/HTTP monitoring, management and control

2.3 Specifications

AT5100 XMOD2 1550nm Externally-Modulated (XMOD2) Laser Transmitter - 19" 1RU

RF Specification

RF Bandwidth	47 MHz to 862 MHz or 47 MHz to 1002 MHz
RF Flatness	±0.75 dB @ 47 MHz to 862 MHz, ±1.5 dB @ 47 MHz to 1003 MHz
RF Input Level	18 dBmV to 28 dBmV
RF Input Return Loss	≥16 dB (47 MHz to 550 MHz), ≥14 dB (550 MHz to 862 MHz)
RF Input Impedance	75 Ω
RF Test Point	-20 dB
TV Channel Plan	60 or 89 PAL channels 80 or 110 NTSC channels

Link Performance

CNR	53 dB (59 ch PAL-D, TX to RX, 0 dBm receive) 51.5 dB (59 ch PAL-D, 65 km fibre, TX with 16 dBm EDFA to RX, 0 dBm receive)
CTB	-65 dBc
CSO	-65 dBc

Optical Specifications

Wavelength	1550 nm ± 5 nm and ITU ch 21, 23, 25, etc.
Line Width	0.65 MHz typical
Optical Output Power, Port 1 & 2	2 × 6 dBm, 2 × 9 dBm (2 × 10 dBm upon request)
Optical Connector	SC/APC
Optical Return Loss	50 Db
SBS Suppression	13 dB to 18 dBm field-adjustable

General Specifications

Operating Temperature	0 °C to +50 °C
Storage Temperature	-40 °C to +85 °C
Power Supply	90 V _{AC} to 265 V _{AC} OR 30 V _{DC} to 72 V _{DC}
Operating Relative Humidity	5 % to 95 % RH (non-condensing)
Power Consumption	<50 W
Dimensions (W × D × H)	483 mm × 368 mm × 44 mm
Weight, kg	5 kg
Ship weight	5.5 kg

Note: Measured in a typical system configuration for the nominated channel numbers and nominated fibre lengths for each model at 25 °C ambient temperature.

2.4 Models and Options

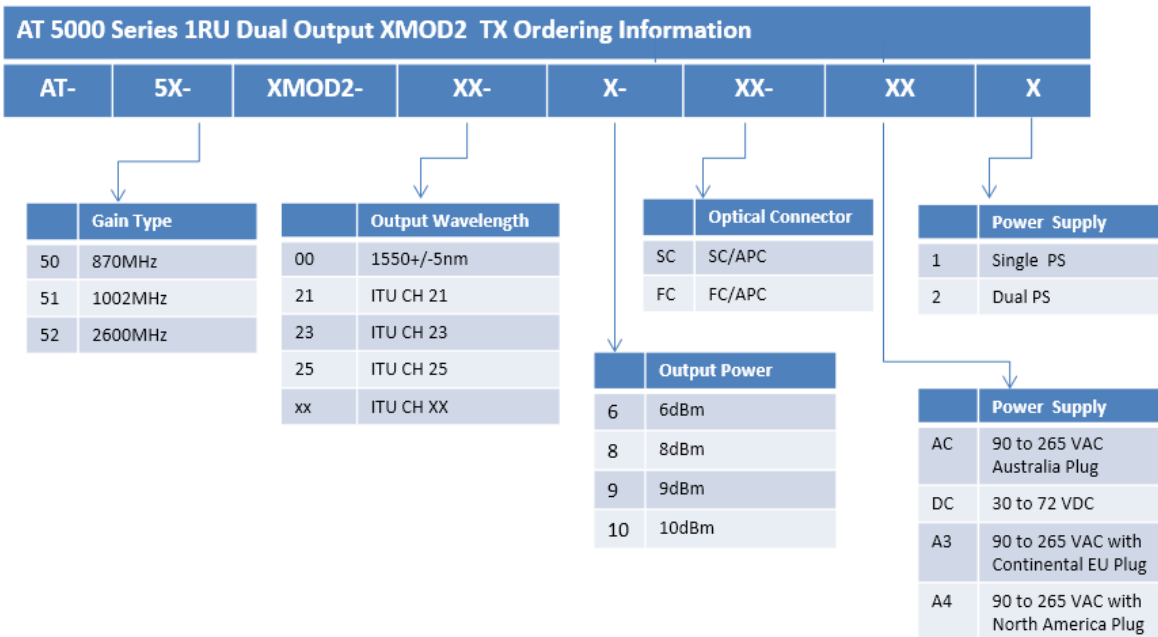

Note

Contact ACT for additional product variations on output power, 1 GHz, specific ITU channels, optical connectors etc.

3 Installation

3.1 Equipment Inventory

On receiving your new AT5100-XMOD2, you should carefully unpack and examine the contents for loss or damage that may have occurred during shipping. Refer to warranty registration if loss or damage has occurred. The AT5100-XMOD2 should consist of the following:

Qty	Description
1	AT5100-XMOD2 Unit
1	Key for switching laser ON / OFF
1	Power supply cord
1	Optional Product User Manual (includes individual test sheet)

3.2 Packaging and Transportation

Keep all AT5100-XMOD2 packing boxes and packaging for future transport.

Use only the original AT5100-XMOD2 packaging when transporting. This packaging has been specifically designed to protect the equipment.

3.3 Power and Cooling Requirements

The AT5100-XMOD2 requires a mains input of 90 V_{AC} to 265 V_{AC} at 50 to 60 Hz. The unit will automatically adjust the power conversion for inputs within these ranges, with no switch setting or other user intervention. Power consumption of the unit is 50 watts maximum.

The transmitter is designed to operate with an ambient temperature of 0 °C to 50 °C with humidity up to 95 %. Free ambient air should be maintained around all sides of the unit. Care should be taken to ensure that the air flow around the unit is unrestricted.

The AT5100-XMOD2 should have a minimum ventilation clearance of 1 RU above and below the transmitter.



Warning

DO NOT expose AT5100-XMOD2 to conditions which would permit condensation to form on the inside of the transmitter.

DO NOT operate AT5100-XMOD2 outdoors.

3.4 Installation and Adjustment



Warning

Exposure to class 1M laser radiation is possible. Access should be restricted to trained personnel only. Do not view exposed fiber or connector ends when handling optical equipment.

The following steps explain how the AT5100-XMOD2 is to be installed.

1. Unpack the transmitter and inspect the unit as stated in **Section 3.1**.
2. Locate the transmitter in a 19" cabinet ensuring adequate ventilation and space for accessing the rear ports and front-panel keypad.
3. Before connecting AC power to the unit, make sure that the LASER ON/OFF key is switched **OFF** (front panel).
4. Use the supplied power cord to apply mains power to the transmitter.
5. Switch the AC power ON (switch located on the rear panel).

The ALARM LED will light red.

The LCD will light and display "Model: AT5100-XMOD2" and "KEY OFF" on start up.

6. Switch on the laser using the key switch.

Front panel shows "KEY ON...", Laser status LCD turns green from red, the unit enters self-checking, after checking it enters working status, display " Descriptor"



Note

Allow 15 minutes for the transmitter to reach its stable operating temperature. Do not connect the optical ports to the network or start aligning your system until then.

7. Before connecting an RF signal, check that the power input level is within the acceptable range. Refer to **Section 2** for details.
8. Connect a matrix generator or head-end RF signal.



Note

The default control mode is AGC. The modulation control mode displayed in the main menu is RF Mode = AGC.

9. Connect a fiber patch-cord from optical port **OPT. OUT 1** to an optical power meter and verify the LCD reading matches your power meter reading.

When the ALARM LED shows green, the transmitter is ready for full operation.

3.5 Front Panel Operation



Port	Item	Description
1	Mounting Points	Holes for securing unit to rack
2	LASER ON/OFF	Key switch for laser activation
3	LASER	Laser indicator GREEN – Output power is normal RED – Abnormal status
4	RF	RF indicator GREEN – Normal operation RED – RF input is too low or too high
5	TEMP	Temperature indicator GREEN – Temperature is normal RED – Operating temperature is too low or too high
6, 7	PWR1/PWR2	Power 1 / Power 2 indicators GREEN – Two-way switch power supply is working YELLOW – One-way power supply is working RED – Abnormal status
8	VFD/LED	VFD/LED display for optical transmitter parameters such as model number and operation status
9, 10	AGC/MGC	AGC/MGC indicator Displays AGC/MGC working status
11	OMI	OMI adjuster Adjust the OMI using a screwdriver. Clockwise rotation increases OMI, counterclockwise rotation decreases OMI
12	KEYPAD	Keypad used to scroll through menu items on transmitter display
13	ENT	Enter button
14	RF TEST	Input level test (-20 dBm)

3.6 Rear Panel Operation

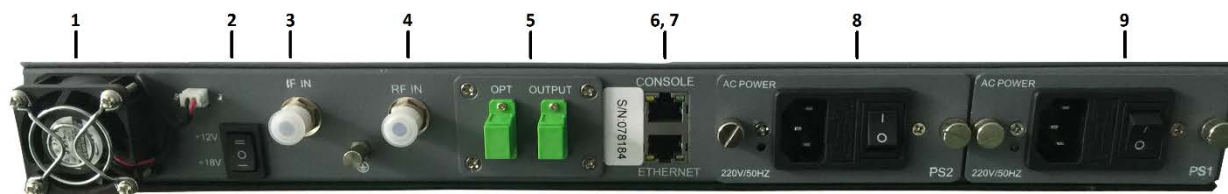

Port	Item	Description
1	FAN	Intelligent fan, begins to run when the chassis temperature reaches 32 °C to 35 °C (set by
2	Power Supply Switch	UP – 12 V DC MIDDLE – Off DOWN – 18 V DC
3	IF IN	IF signal input
4	RF IN	RF signal input
5	OPT OUTPUT	Optical signal output
6	CONSOLE	Console for computer network management
7	ETHERNET	Ethernet port, compliant with CNMP standard interface
8, 9	PS2/PS1	Power supply 2 outlet



Note

Product appearance may vary with model options.

4 Technical Description

4.1 Overview

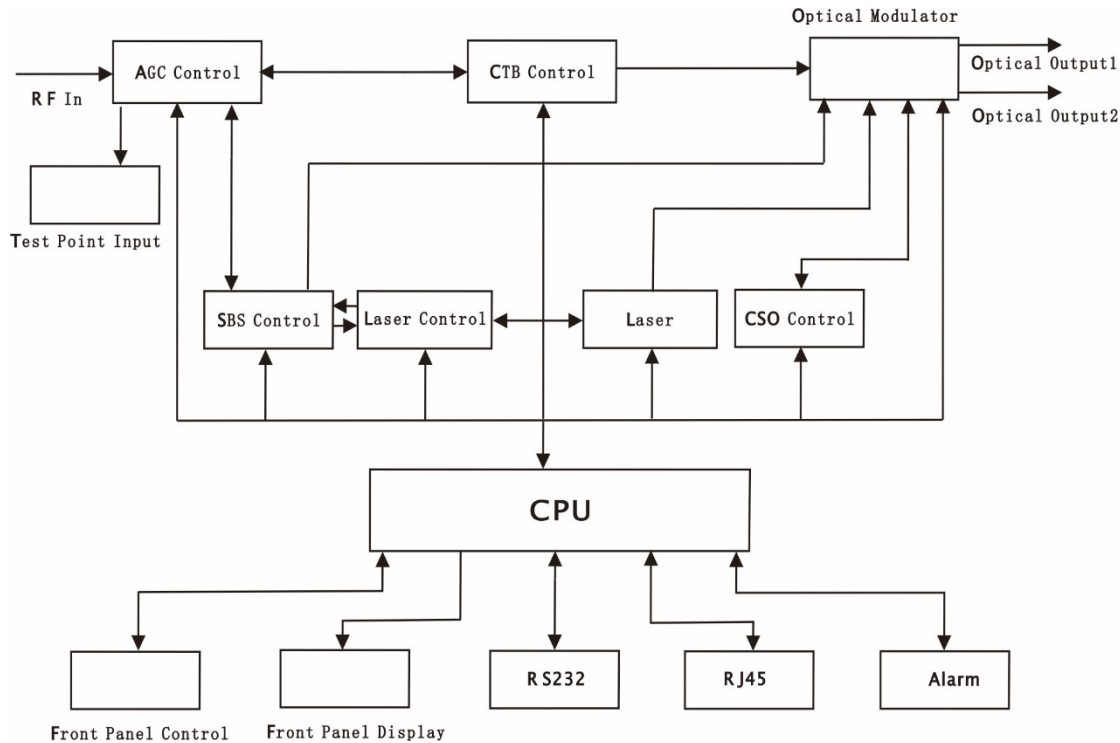

4.2 Physical Description

The unit is housed in a 19" rack, 1 RU height. Status indicators and control keys are located on the front panel along with an RF monitor port. The front panel provides an LCD display for comprehensive status information and user interface. The rear panel contains the optical interconnects, power, and data interface connectors.

The RF test port on the front panel is -20 dB from the modulating signal level. This is just after the internal AGC functional block. This signal is constant when the AGC circuit is functioning normally. Refer to the specification for typical levels. The output impedance of this port is 75 Ω , with an F-type connector.

The rear panel also contains the two optical ports, which are typically SC/APC bulkhead connectors.

The power interface, is a standard 3-prong line cord, with hot, neutral, and chassis ground. The metal chassis of the transmitter is tied to ground.

4.3 AGC Operation

The AT5100-XMOD2 will be in AGC mode (Automatic Gain Control) when first powered on. To change it to MGC mode (Manual Gain Control), refer to **Section 5.3**.

4.4 SBS Suppression

The SBS suppression circuitry is based on industry techniques for line-width broadening the source. All of these schemes involve spreading out the optical power so that the optical power in any one region of the optical spectrum does not exceed the threshold at which SBS effects start to become evident.

The SBS suppression of the externally modulated laser transmitter needs to be optimized for the best possible CSO performance. The selected value needs to match the maximum optical drive level in the fiber lines. For short lines this level can be a bit higher than for very long lines. A reduced line drive level together with a reduced SBS suppression threshold in the transmitter increases the maximum achievable system range. The AT5100-XMOD2 incorporates field-selectable SBS thresholds. Ensure that the selected level will match the fiber line drive level as close as practical for best performance.

Follow the steps below to determine the correct SBS value for your optical network.

1. Look at the network design that the TX will be used in and determine the highest optical power launched into the actual transmission fiber. Keep in mind this is not necessarily the launch power out of the EDFA or the power into the passive devices that may be placed ahead of the fiber. If possible, measure the actual power that will be launched into the transmission fiber.
2. After determining the highest value of optical launch power in the network record this value.
3. Now, using the SBS adjust menu on the front panel, set the SBS threshold to this value you have recorded in step 2. Your system is now at its optimized operating point for both CNR (low frequencies) and CSO (high frequencies).
4. If this value is higher than +18 dBm then you will have to add loss to your optical network at this point, the transmitter does not support a SBS level higher than this.
5. If this value is lower than +14 dBm then set the TX to this minimum setting and your network will be at its optimized operating point.
6. To verify that you are not beyond the SBS threshold or that the TX SBS setting is correct, you can measure the CNR at the lowest frequency channel in your system. If the CNR is within specification then you do not have any SBS setting issues.

4.5 ITU Frequency Grid

The following table contains the ITU frequency plan with corresponding wavelengths available to the AT5100-XMOD2.

Channel	ITU Freq. (THz)	Avail. ITU Wavelengths (nm)	Channel	ITU Freq. (THz)	Avail. ITU Wavelengths (nm)
Order Code			Order Code		
60	196.0	1529.55	40	194.0	1545.32
59	195.9	1530.33	39	193.9	1546.12
58	195.8	1531.12	38	193.8	1546.92
57	195.7	1531.90	37	193.7	1547.72
56	195.6	1532.68	36	193.6	1548.51
55	195.5	1533.47	35	193.5	1549.32
54	195.4	1534.25	34	193.4	1550.12
53	195.3	1535.04	33	193.3	1550.92
52	195.2	1535.82	32	193.2	1551.72
51	195.1	1536.61	31	193.1	1552.52
50	195.0	1537.40	30	193.0	1553.33
49	194.9	1538.19	29	192.9	1554.13
48	194.8	1538.98	28	192.8	1554.94
47	194.7	1539.77	27	192.7	1555.75
46	194.6	1540.56	26	192.6	1556.55
45	194.5	1541.35	25	192.5	1557.36
44	194.4	1542.14	24	192.4	1558.17
43	194.3	1542.94	23	192.3	1558.98
42	194.2	1543.73	22	192.2	1559.79
41	194.1	1544.53	21	192.1	1560.61

5 Software Description – Operation

5.1 Web Management

The user can use web browser to check the working condition and basic parameters of the amplifier, it supports IE, Chrome, Firefox, Opera and other main web browser. The following example are based on Opera browser.

1. Find the IP add in the machine, normally it is 192.168.1.XXX, set the IP add of the PC in the same range as following:

Step 1: Open local Area Connection setting:

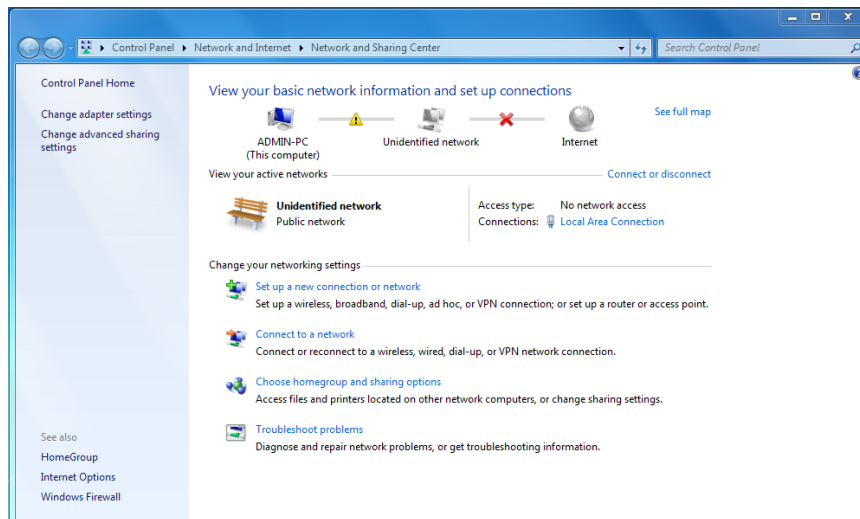

Step 2: Set Properties

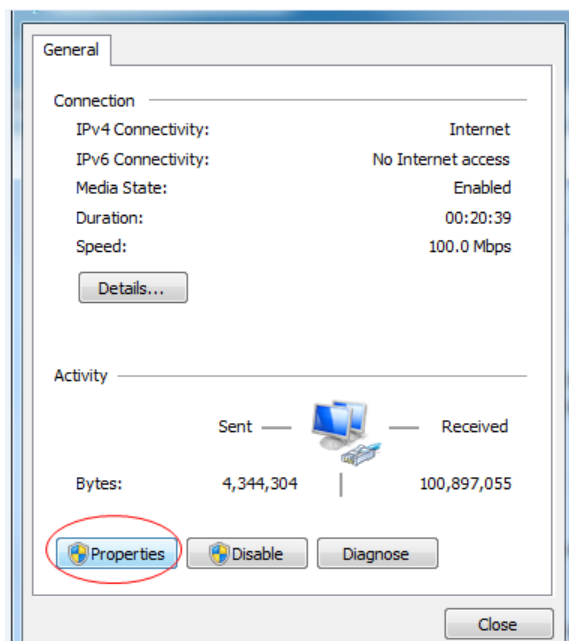

Step 3: Set the PC IP address in the same range with device IP address. For example the device IP address is 192.168.1.122, pls set PC IP address to 192.168.1.X (X different to 122).

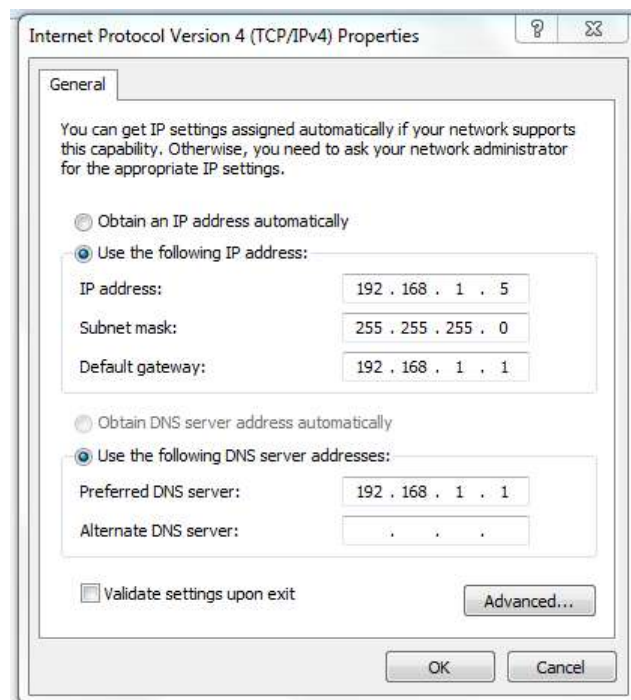
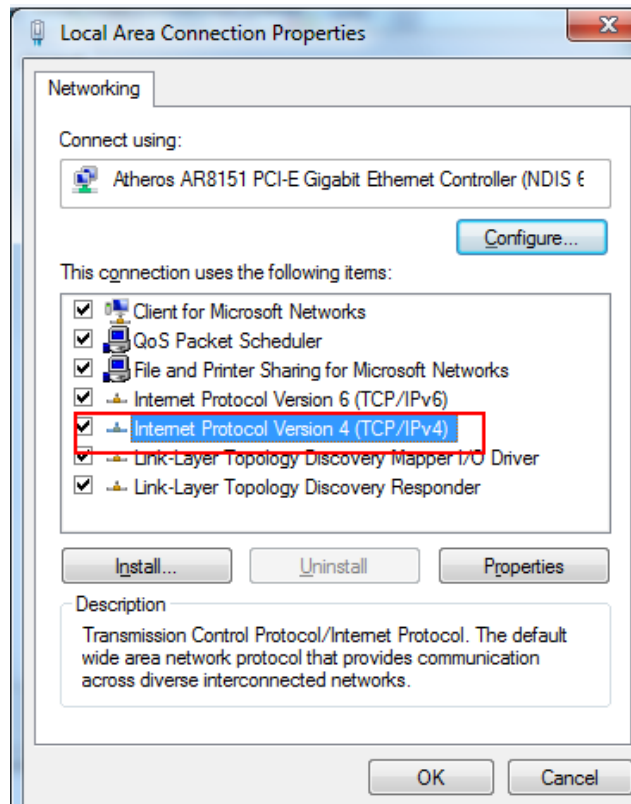

2. Open web browser, input the IP add and login in. The IP factory setting is 192.168.1.122.

User Name: admin

Password: ascent

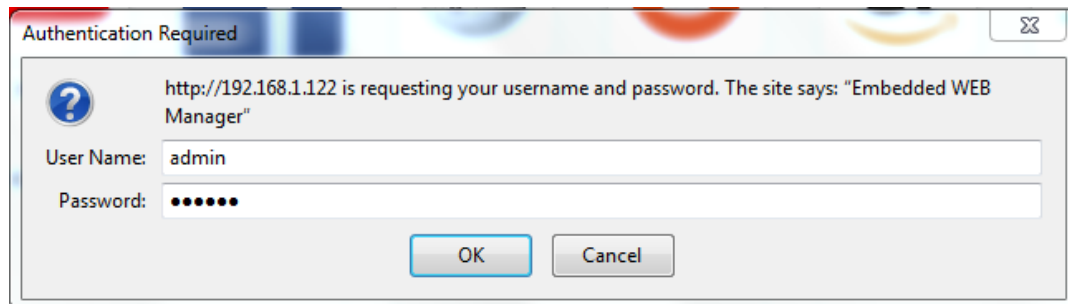
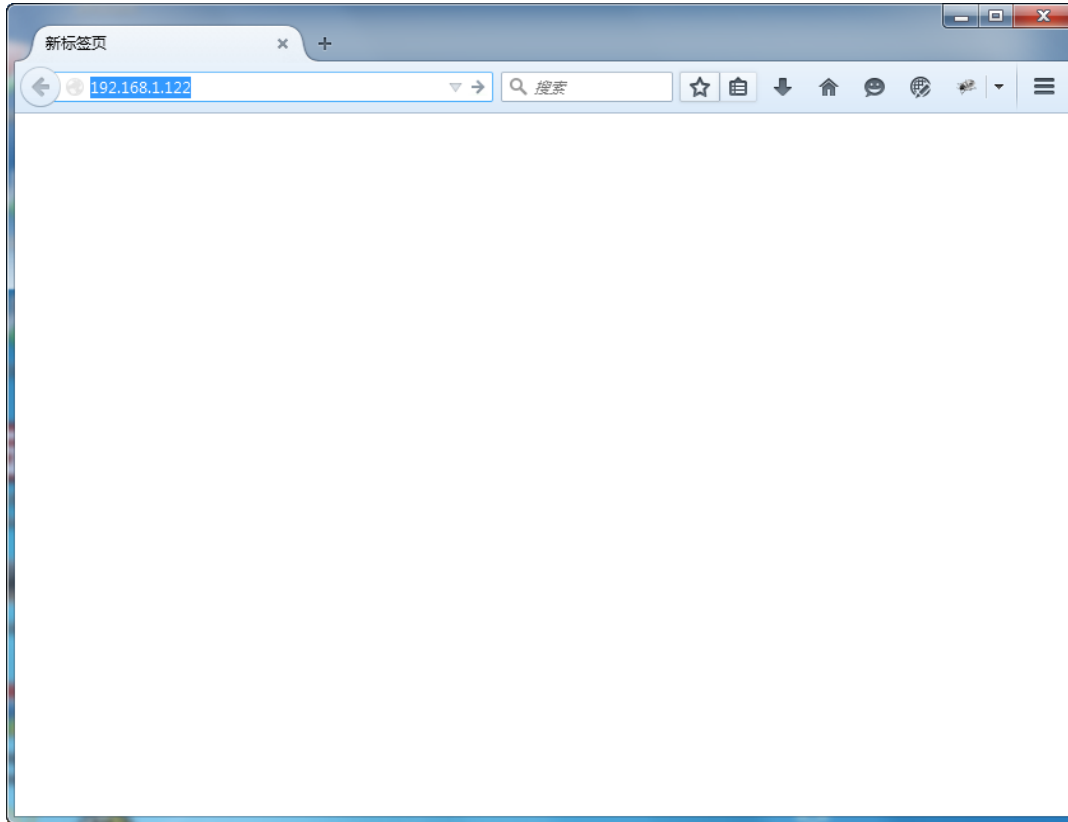

3. The web management consist of five submenus. Items guide on the left, click to enter.

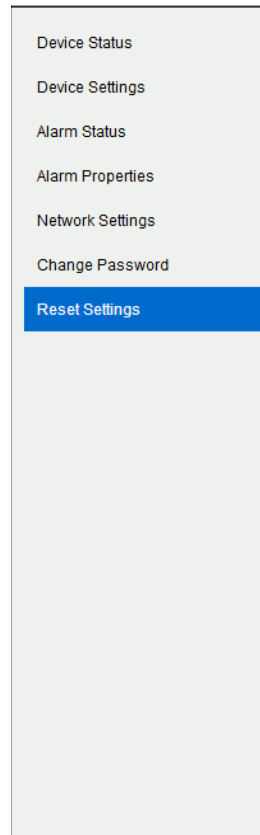

5.2 Device Status Submenu

The screenshot shows the 'Device Status' submenu of the ASCENT WEB Manager. The left sidebar contains the following menu items: Device Status (selected), Device Settings, Alarm Status, Alarm Properties, Network Settings, Change Password, and Reset Settings. The main content area displays the following device status information:

Parameter	Value	Unit
Device Model	AT-51-XM002-00-10-SC	
Serial Number	180202081883	
Version	7.0.1	
Unit Temperature	24.9	°C
Input RF Level	50.0	dBmV
Output Power1	10.3	dBm
Output Power2	10.0	dBm
Wavelength	1556.15	nm
Laser BIAS	195	mA
Laser TEMP	25.0	°C
Laser TEC	0.21	A
DC Power ~24V	24.0	V
Power Supply 1	Fault	
Power Supply 2	Normal	
FAN Status	OFF	

Copyright © 2011-2017 Ascent Communication Technology Limited

5.3 Device Settings Submenu

OMI mode: switch AGC/MGC statuses.

OMI Value: -3 dB to +3 dB adjustable, factory setting is 0 dB.

SBS: 13 dB to 19 dB continuously adjust, 0.1 dBm step 0.1 dB.

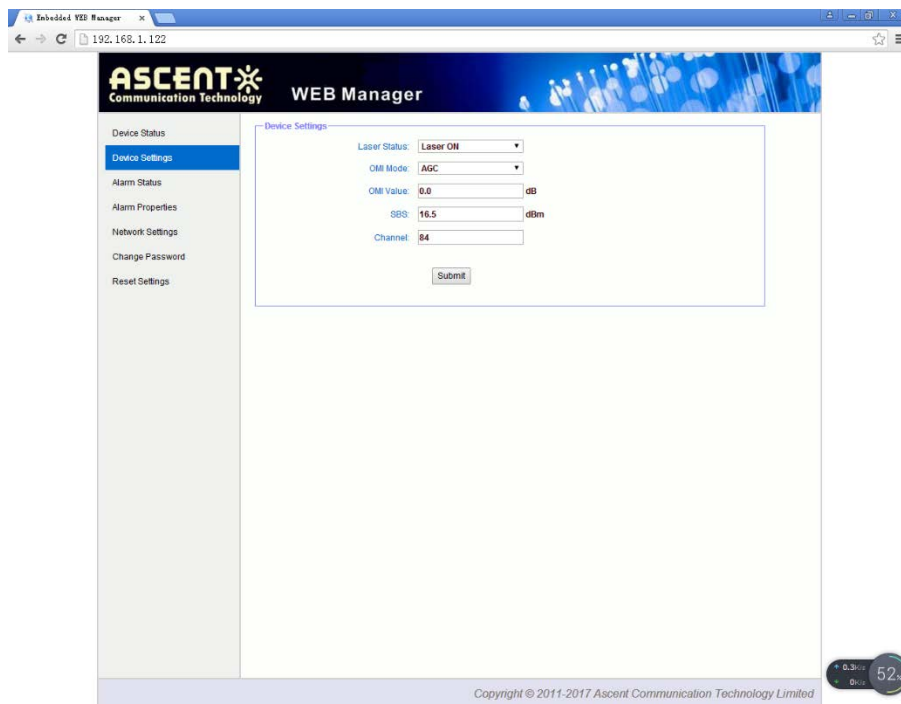

5.4 Alarm Status



5.5 Alarm Properties

The screenshot shows the 'Alarm Properties' configuration page in the ASCENT WEB Manager. The left sidebar lists navigation options: Device Status, Device Settings, Alarm Status, Alarm Properties (selected), Network Settings, Change Password, and Reset Settings. The main content area displays two tables for configuring alarms.

Index	Parameter Name	HRR	HR	LO	LOLO	Deadband	Action
1	Box Temp (°C)	85	70	0	-5	2	Set
2	Input RF Level (dBuV)	120.0	110.0	60.0	50.0	1.0	Set
3	Laser Current (mA)	1000	800	100	50	5	Set
4	Laser Outpower (mW)	20	18	2	1	1	Set
5	Laser Temp (°C)	35	32	18	15	1	Set
6	Laser TEC (mA)	3000	2000	-2000	-3000	10	Set
7	Laser Outpower1 (dBm)	15.0	14.0	1.0	0.5	0.1	Set
8	Laser Outpower2 (dBm)	15.0	14.0	1.0	0.5	0.1	Set
9	DC +24V (V)	28.0	27.0	21.0	20.0	0.2	Set

Index	Parameter Name	Control	Action
1	Power Supply 1	EnableMajor	Set
2	Power Supply 2	EnableMajor	Set
3	Input RF Status	EnableMajor	Set
4	FAN Status	EnableMajor	Set

Copyright © 2011-2017 Ascent Communication Technology Limited

5.6 Network Settings:

The screenshot shows the 'Network Settings' configuration page in the ASCENT WEB Manager. The left sidebar lists navigation options: Device Status, Device Settings, Alarm Status, Alarm Properties, Network Settings (selected), Change Password, and Reset Settings. The main content area displays various network configuration fields.

Device MAC: 08 : 29 : 16 : 57 : 04 : 4A

Update Identifier: OTX1385G03

Agent Version: V1.0.0

Static IP Address: 192 . 168 . 1 . 122

Subnet Mask: 255 . 255 . 255 . 0

Default Gateway: 192 . 168 . 1 . 1

Trap Address 1: 192 . 168 . 1 . 200

Trap Address 2: 255 . 255 . 255 . 255

Trap Address 3: 192 . 168 . 1 . 10

Trap Address 4: 0 . 0 . 0 . 0

Trap Address 5: 0 . 0 . 0 . 0

Trap Address 6: 0 . 0 . 0 . 0

Trap Address 7: 0 . 0 . 0 . 0

Trap Address 8: 0 . 0 . 0 . 0

Read Community: public

Write Community: public

Trap Community: public

SNMP Version: V1

Save

Copyright © 2011-2017 Ascent Communication Technology Limited

5.7 Change Password

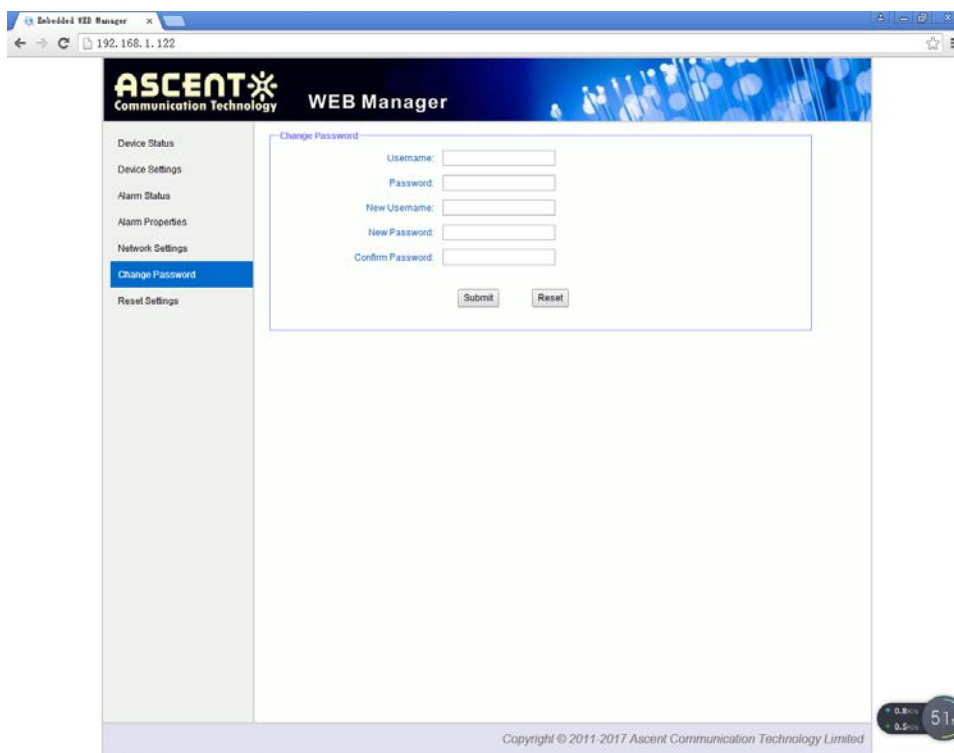

5.8 Reset Settings

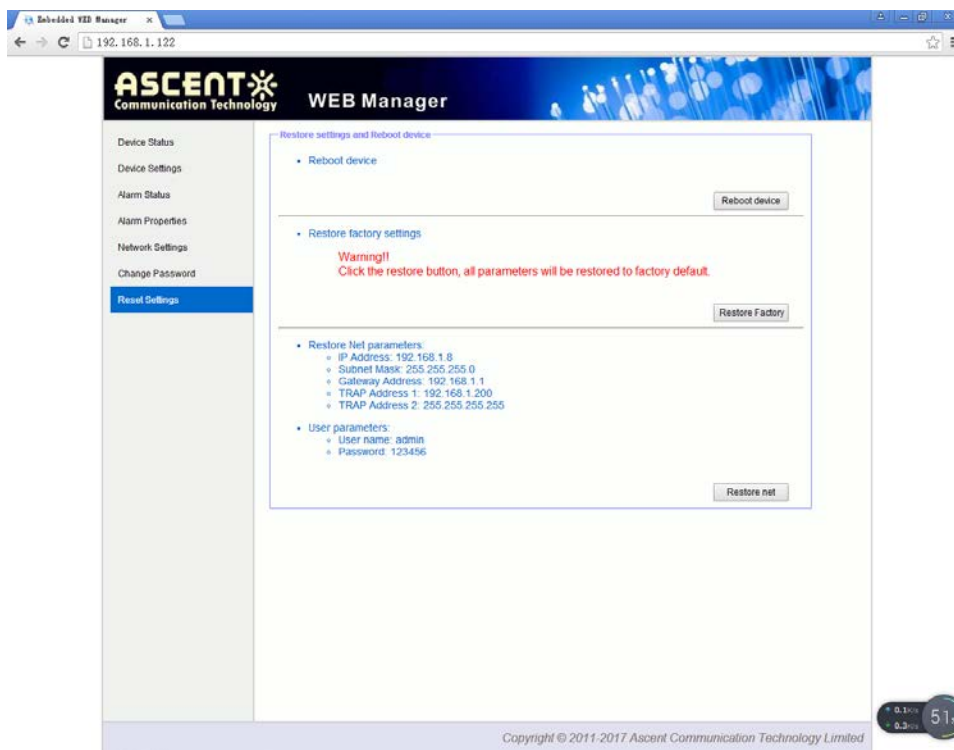

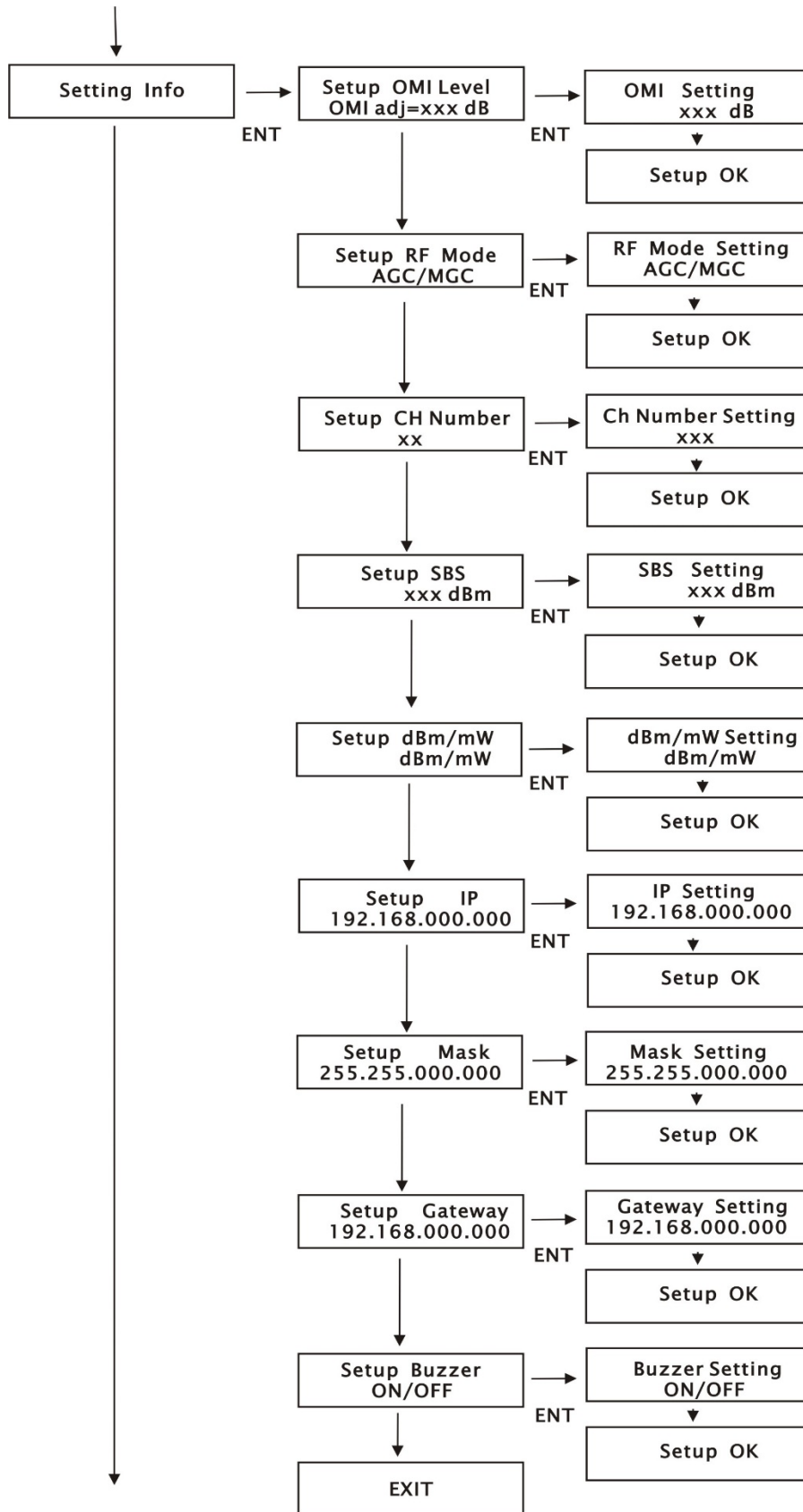

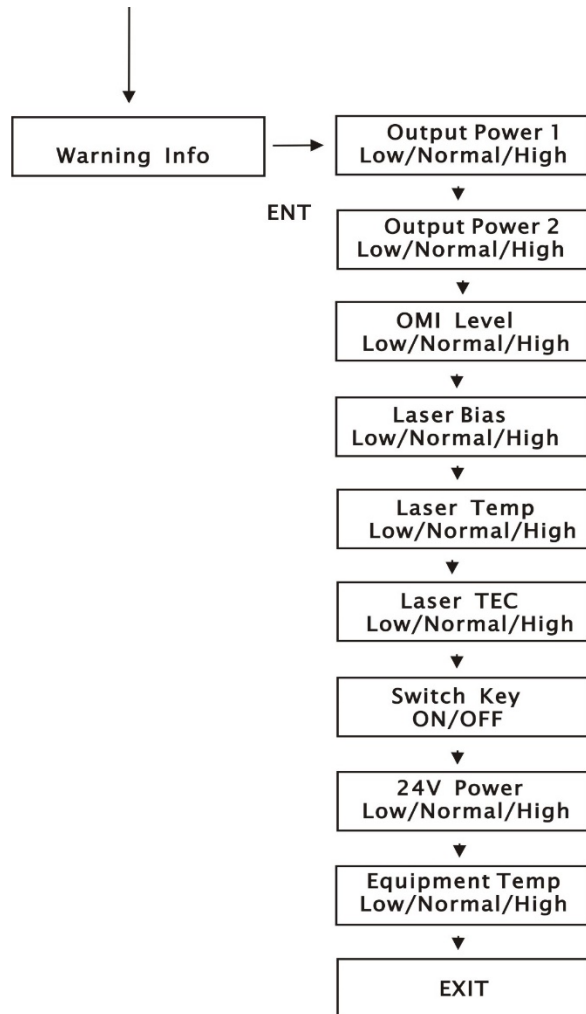

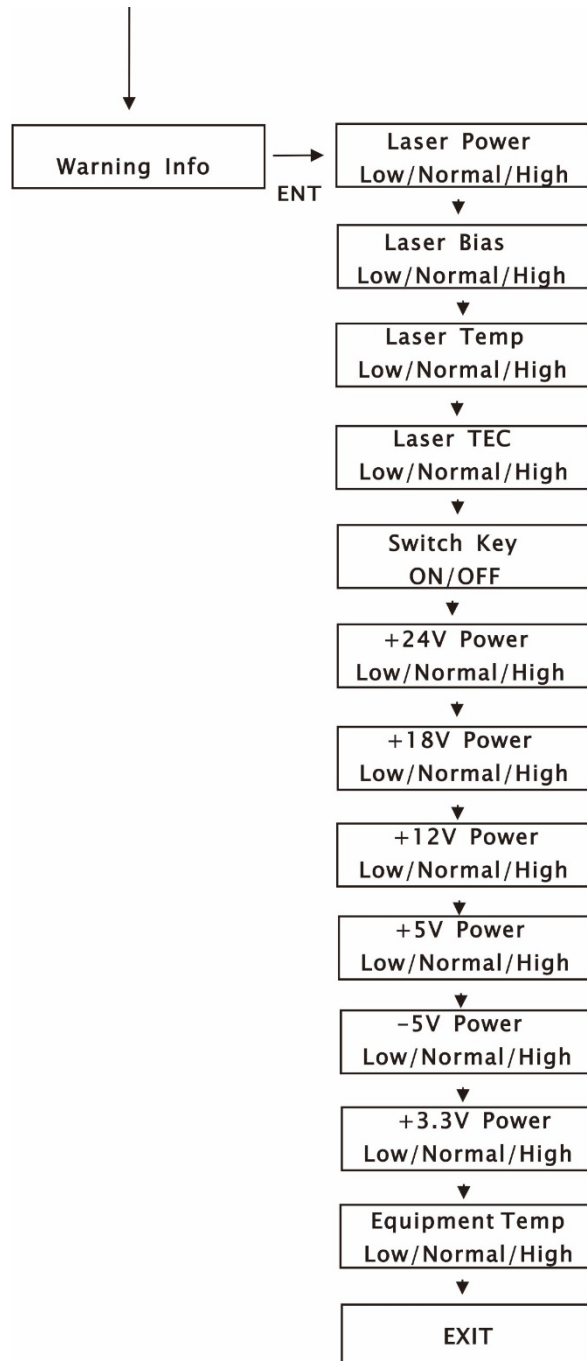



GERMANY

Langwiesenweg 64-71
75323 Bad Wildbad, GERMANY
Phone: +49 (0) 7081 / 17 02 0

WEB: www.polytron.de



Ascent Communication Technology Ltd

AUSTRALIA

140 William Street, Melbourne
Victoria 3000, AUSTRALIA
Phone: +61-3-8691 2902

HONG KONG SAR

Unit 9, 12th Floor, Wing Tuck Commercial Centre
177 Wing Lok Street, Sheung Wan, HONG KONG
Phone: +852-2851 4722

CHINA

Unit 1907, 600 Luban Road
200023, Shanghai CHINA
Phone: +86-21-60232616

USA

2710 Thomes Ave
Cheyenne, WY 82001, USA
Phone: +1-203 816 5188

WEB: www.ascentcomtec.com

EMAIL: sales@ascentcomtec.com

Specifications and product availability are subject to change without notice.
Copyright © 2018 Ascent Communication Technology Limited. All rights reserved.
Ver. ACT_1RU_AT5100_XMOD2_QRG_V1b_Feb_2018